



HOBO U30 USB Station

U30-NRC

Included Items:

- Mounting kit
- Cable channel kit
- Grounding wire

Required Items:

- HOBOWare Pro
- USB cable
- AC adapter (AC-U30 or AC-U30-EU) or solar panel (SOLAR-xW)

Optional Items:

- Smart sensors
- Analog sensor port
- Smart sensor expander board (S-ADAPT-X5-10)
- Tripod kit (M-TPA or M-TPB)
- Guy wire kit (M-GWA)

Sensors and accessories are available at www.onsetcomp.com.

The HOBO U30 USB Station is a weatherproof data logger designed for environmental monitoring applications. This rugged logger has a built-in rechargeable battery and supports up to 10 plug-and-play smart sensors and two optional analog inputs with sensor excitation. With HOBOWare® Pro, you can easily configure the logger, check the status, and download data for graphing and analysis. You can also use HOBOWare Pro to set up a relay that can be activated on alarm conditions. **Note:** U30 stations with remote communication capability are no longer available. RX3000 stations are available in Ethernet, Wi-Fi, and cellular models. See www.onsetcomp.com for details.

Specifications

Station

Normal Operating Range	-20 to 40°C (-4 to 104°F)
Extended Operating Range	-40 to 60°C (-40 to 140°F) NOTE: Operation within the extended operating range (but outside the normal range) will reduce battery service life.
Smart Sensor Connectors	5 standard, option to expand to 10
Smart Sensor Network Cable Length	100 m (328 ft) maximum
Smart Sensor Data Channels	Maximum of 15 (some sensors use more than one data channel; see sensor manual for details)
Logging Interval	1 second to 18 hours
Start Modes	Immediate, at interval, push button, or delayed start
Memory Modes	Stop when full or wrap when full
Memory	512 KB nonvolatile flash data storage
Alarm Output Relay	One relay contact closure can be configured as normally open, normally closed, or pulsed. Voltage: 30 V Current: 1 amp max.
Operational Indicators	Three status lights provide basic diagnostics
Time Accuracy	0 to 2 seconds for the first data point and ±5 seconds per week at 25°C (77°F)
Battery Type/Power Source	4 Volt, 10 Ahr, rechargeable sealed lead-acid; external power required using one of these options: AC power adapter (AC-U30) or solar panel (SOLAR-xW)
Rechargeable Battery Service Life	Typical 3–5 years depending upon conditions of use. Operation within the extended operating range (but outside the normal range) will reduce battery service life.
Communication Type	Full speed USB via USB mini-B connector
Full Memory Download Time	4 minutes
Enclosure Access	Hinged door secured by two latches with eyelets for securing with user-supplied padlocks
Materials	Outer enclosure: Polycarbonate/PBT blend with stainless steel hinge pins and brass inserts Inner enclosure: Polycarbonate with brass inserts U-Bolts: Steel with zinc dichromate finish Gaskets: Silicone rubber Cable entry channel: EPDM rubber Cable entry bars: Aluminum, metal thumbscrews with plastic heads
Dimensions	18.9 H x 11.8 D x 18.1 W cm (7.4 H x 4.7 D x 7.1 W inches) (see diagrams on next page)
Weight	2.2 kg (4 lbs 13 oz)
Mounting	3.8 cm (1.5 inch) mast or wall mount

Specifications (continued)

Environmental Rating	Weatherproof enclosure, tested to NEMA 6 (Requires proper installation of cable channel system)
-----------------------------	---

CE	The CE Marking identifies this product as complying with all relevant directives in the European Union (EU).
-----------	--

Analog Sensor Port

Input Channels	Two, single-ended
-----------------------	-------------------

Field Wiring	Two- or three-wire via screw terminals on detachable connector, 16–24 AWG
---------------------	---

Replacement Detachable Connectors	Part of spares kit, Part No. A-FS-CVIA-7P-1
--	---

Input Range	User-configurable: 0–20 mA DC, 0–2.5 VDC, 0–5 VDC, 0–10 VDC, and 0–20 VDC (the voltage range is determined based on the raw values entered for the voltage scaling in HOBOWare)
--------------------	---

Minimum/Maximum Input Voltage	0 / 24 VDC
--------------------------------------	------------

Minimum/Maximum Input Current	0 / 24 mA DC
--------------------------------------	--------------

Minimum Current Source Impedance	> 20 K Ω
---	-----------------

Accuracy	$\pm 0.25\%$ of FSR from 50mV to FSV
-----------------	--------------------------------------

ADC Resolution	12 bits
-----------------------	---------

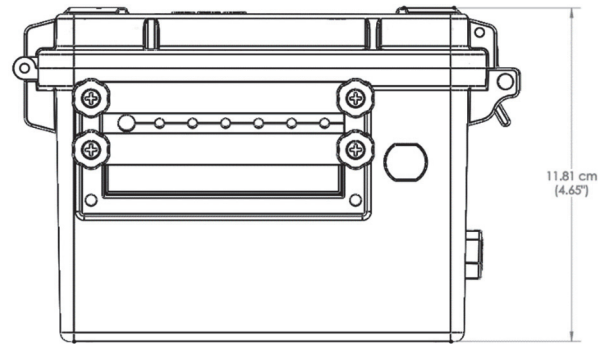
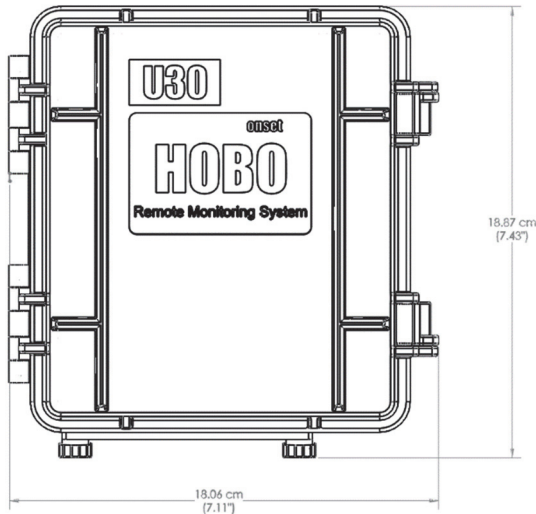

Device Components

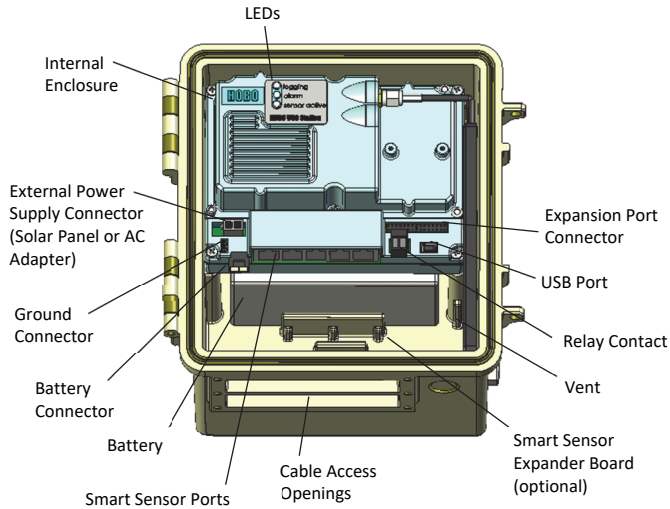

Internal Enclosure: This weatherproof enclosure provides a second level of protection for the U30 electronic circuitry. Do not open this case; doing so will void the warranty.

LEDs: There are three LEDs that indicate logger activity and status.

LED	Description
Logging	<p>Green: The station is currently logging data.</p> <p>Red: There was a sensor failure. Check for loose connections and remove the offending sensor. Check the wire and connector for damage or signs of moisture. See <i>Troubleshooting</i> for more details.</p> <p>Orange: There was a communication failure, but the system recovered. There may be an intermittent problem. Try checking the smart sensors one at a time to make sure they are all communicating. See <i>Troubleshooting</i> for more details.</p>
Alarm	An alarm has tripped.
Sensor Active	There is activity with the smart sensor network communications.

Expansion Port Connector: This is location where the optional, two-channel analog sensor port is factory-installed. The analog sensor Port can accept and provide excitation power to a wide range of Onset and third-party sensors and features input protection and signal filtering, as well as delta-sigma A/D conversion and factory calibration. The station can provide 12 V DC sensor excitation voltage up to 50 mA total for transducers that require external power for proper operation. See *Setting up and Starting the Station* for details on connecting sensors to and configuring the Analog Sensor Port.

USB Port: Plug in a USB cable into this port to connect to a computer.

Relay Contact: This can be activated, deactivated, or pulsed on user-defined sensor alarms. The relay contact can be configured as normally open or normally closed, and is rated for 30 V, 1 Amp maximum. See *Setting up the Relay Contact* for more details.

Vent: This vent allows pressure to equalize inside the enclosure, but does not allow liquid to pass through. **Note:** The pressure inside the station may not match the outside air

pressure exactly so a barometric pressure sensor deployed within the station cannot measure the true atmospheric pressure unless it has its own unrestricted vent to the outside.

Smart Sensor Expander Board: The optional smart sensor expander board that can support up to five additional sensors is installed here.

Cable Access Opening: All cables and wires are pulled through a protective rubber cable channel placed in this opening. If you are using the optional smart sensor expander board, you will need to use the second cable access opening.

Smart Sensor Ports: Connect up to five smart sensors in these RJ-12 jacks. Use one jack to connect the optional expander board for additional smart sensors.

Battery: 4-Volt Sealed Lead Acid (SLA) battery located inside the case.

Battery Connector: Plug in the battery in this port.

Ground Connector: Plug in the grounding wire in this port to ground the system.

External Power Supply Connector: Plug in the compatible solar panel or AC adapter here.

Important: Always connect the battery before plugging in an external power supply. Always disconnect external power before disconnecting the battery. Damage may occur if the battery is unplugged before the external power is disconnected.

Setting up and Starting the Station

Follow these steps to set up the station.

- 1. Install the mounting plates.** Screw the mounting plates onto the back of the HOBO U30 Station case using a Phillips-head screwdriver. Be careful to orient the plates as shown below so that the screw heads are sunk into the screw holes.

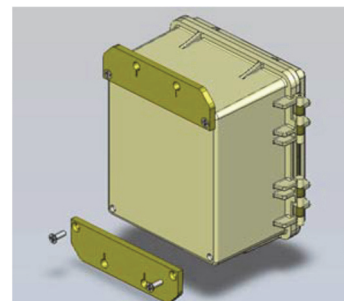

2. **Remove the secondary cable slot and install the smart sensor expander board.** If you are using the optional smart sensor expander board, follow these steps to remove the piece covering the secondary cable slot to access the board and then install it if necessary. **Note:** The station must be turned off with all cables disconnected before beginning.

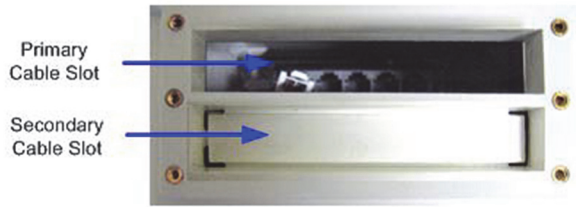

- a. Use a hammer and a bladed tool (e.g., screwdriver, chisel) to punch through at the four corners and at the ends of the piece covering the secondary cable slot.



- b. Punch through along the bottom of the knockout and then tap sharply in the middle to break into the opening. Remove the hanging flap.



- c. Peel away any residual material.



- d. File any rough edges. For best results, the surfaces in the cable access opening should be smooth so that the rubber cable channel gasket will seal.

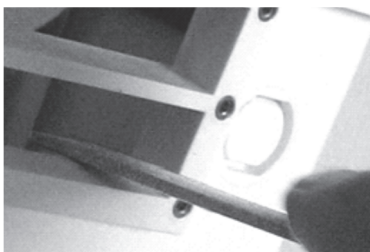

- e. If the smart sensor expander board is already installed, skip to the next section. Otherwise, insert a self-tapping screw (supplied) into each end of the expander.
- f. Lower the expander onto the two standoffs near the bottom of the case and screw the expander into place.

Alternate Method: Place the expander (without the screws) onto the standoffs. Apply a small amount of clear grease (the grease supplied with this kit can be used) at the end of the screwdriver to hold screws while lowering them into place.

Note: The contacts of the expander jacks should be nearest to the bottom of case as shown in the following example. Be careful not to trap the battery cable behind the board.

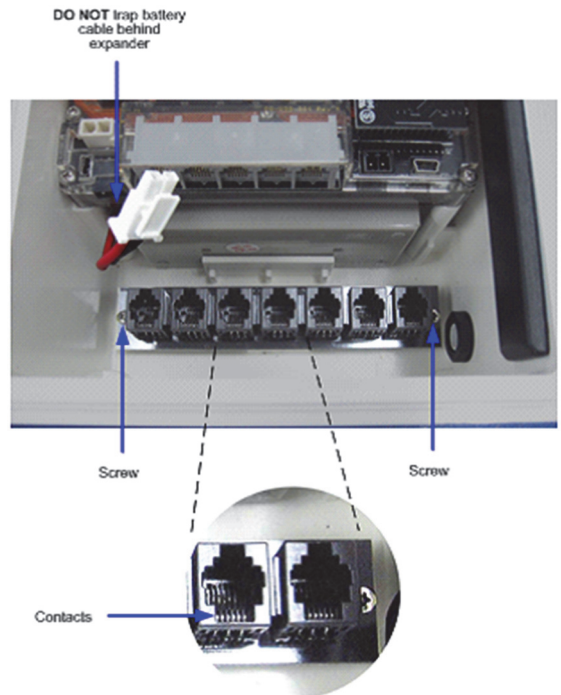

- g. Plug one end of the supplied expander cable into the rightmost jack of the expander board. Plug the other end into the rightmost jack of the built-in board.



3. **Connect sensors and optional relay equipment.** Follow these steps to connect smart sensors, analog sensors, and relay equipment to the station. If you are using the smart sensor expander board, connect sensors to those ports before connecting the sensors through the primary cable slot.

- a. Run cables through the Secondary Cable Slot.

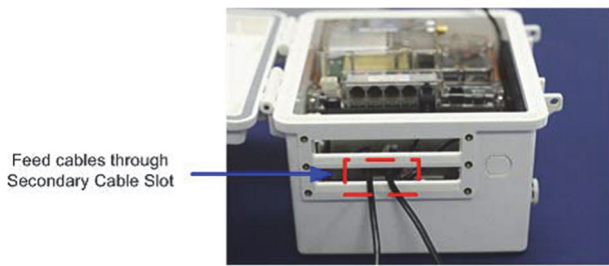

b. Plug the cables into the smart sensor expander board.

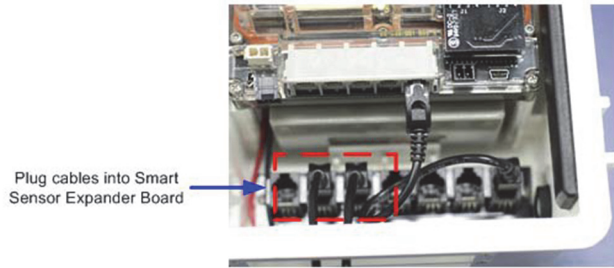

c. Run cables for the remaining smart sensors through the primary cable slot and connect the cables into the primary smart sensor ports.

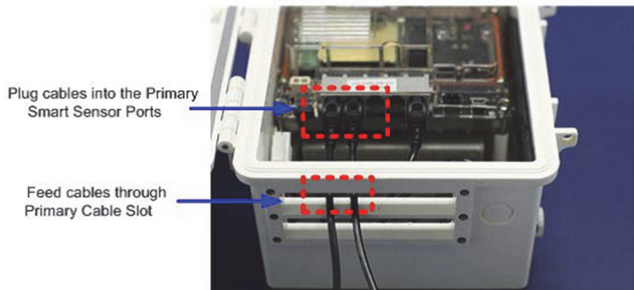

d. To connect a two- or three-wire sensor or transducer to the terminals in the optional analog sensor port: Loosen the screw for each pin on the connector. Insert the appropriate wire into the screw terminal (see the pinout table below). Make sure all wires attached to the analog sensor port are routed through the cable access opening. Tighten the screws. Refer to the specific sensor documentation for terminal connection details. **Note:** To maintain a weatherproof seal, the analog sensor cables must be the right diameter (see the note following step e for more details).

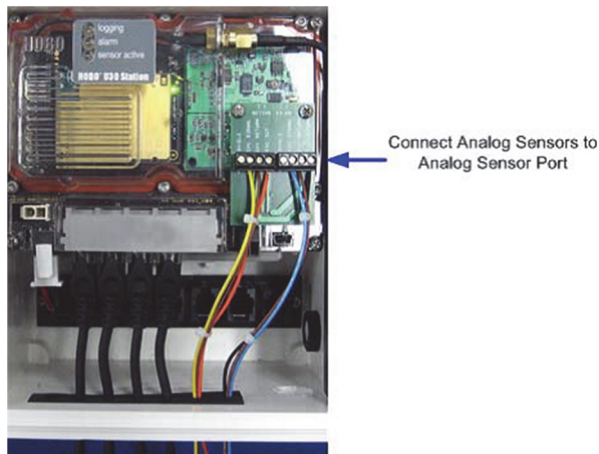

Pin# Left	Function	Pin# Right	Function
1	Shield	1	Shield
2	Channel 1 Signal	2	Channel 2 Signal
3	Channel 1 Return	3	Channel 2 Return
4	Excitation Voltage	4	Excitation Return

e. Connect external equipment to the relay screw terminal, making sure any wires are routed through the cable access opening. **Note:** The relay contacts are designed for low power switching (see specification for rating). To switch higher power, use an appropriately rated relay and the U30 station relay to switch the external relay on and off.

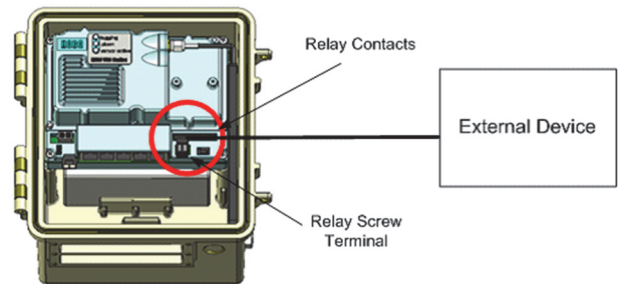

Note: To fit into the holes in the rubber cable channel that will be installed when you are ready to deploy, the ideal cable diameter is 0.157 in (4.0 mm). If the cable is too small, build up the diameter using heat shrink. If it is too big and you are using the secondary cable access opening, then place the cable through the left-most hole in the rubber cable channel where the diameter can be up to 0.25 in (6.4 mm). If you are not using the secondary opening or the cable is still too big, then splice on another cable with a smaller diameter to fit through the hole. See *Deploying and Mounting the Station* for details on working with the rubber cable channel.

4. **Connect the battery.** Connect the built-in battery cable to the battery as shown below.

WARNING: Do not plug in battery here. This is for the solar panel or optional AC adapter.

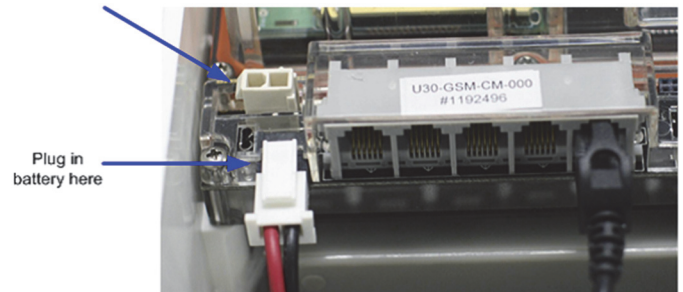

5. **Connect the U30 station to a computer with HOBOWare Pro installed.** Plug the small end of the USB cable into the USB port on the station and the large end in the USB port on the computer and open HOBOWare Pro. **Note:** Device hardware drivers will be installed automatically the first time the station is connected. This may take a few minutes to complete.

6. Configure analog sensor ports.

If you are using analog sensors, configure the analog sensor port.

- a. From the Device menu in HOBOWare Pro, select Configure Modules/Ports.
- b. In the Select Sensor to Configure window, click the + sign to see the available modules/ports. **Note:** The default channel names Voltage and Current can be configured to measure voltage or current. For example, both channels can be used to monitor sensors with 4-20 mA output.
- c. Select a sensor and then click the Configure button to open the Configure Sensor window.
- d. In the Configure Sensor window, select the Sensor Name (choose a default name or type your own name).
- e. Select one of following excitation power modes:
 - Warm-up mode. The logger supplies excitation power for a brief, user-programmable period prior to each measurement, which allows you to select the minimum warm-up time needed to allow for sensor stabilization while conserving battery power. For example, if you specify a warm-up of one second and set the logging interval to one minute, the HOBO U30 Station will power the external sensor for one second, log a measurement, and then turn off the excitation power for the next 59 seconds. The warm-up time can be set from 5 milliseconds up to 120 seconds. **Note:** If the warm-up time selected is greater than the logging interval selected, the logger will interpret the excitation mode as continuous.
 - Continuous mode. The logger supplies constant excitation power to the sensor for the entire duration of the deployment, which will result in reduced battery life. Continuous mode is required if the sensor needs more than two minutes of warm-up time.
- f. Select the measurement type and enter any scaling values. Enter the low value for the sensor in Raw Value 1 and the high value in Raw Value 2. For example, if the range is 0–20 mA, then Raw Value 1 would be 0 and Raw Value 2 would be 20. Enter the Scaled Value 1 and Scaled Value 2. See the HOBOWare Help for additional details on scaling.
- g. Click Configure. **Note:** During logging, the Active indicator LED on the analog sensor port blinks once per logging interval to indicate that a successful measurement has been made. The Ex. On indicator LED will also be lit when excitation is enabled.

7. Configure launch settings.

- a. From the Device menu in HOBOWare Pro, select Launch.
- b. In the Launch Logger window, type a name for the launch, which will be used as the filename for data readouts. Select a logging interval, which is how often the station logs data from the sensors (select 10 seconds for an optional initial test). Choose any other settings as desired. Select a Start Logging option, which determines when the station will be launched (select Now for an optional initial test).
- c. Click the Start button.

8. **Test the U30 and sensors.** To verify the U30 station and sensors are working properly, select Status from the Device menu. If you set up a fast logging interval for an initial test, change the sensor readings by changing the conditions. For example, hold the temperature sensor in your hands for a minute or two and verify that the temperature shown in Current Readings increases.

You are ready to deploy the logger:

- Launch the logger again with your desired logging rate if you ran a test with a fast logging interval.
- Disconnect the USB cable.

Important: When you deploy the logger, make sure you connect the solar panel or AC adapter to charge the battery. If at any point you need to unplug the battery, unplug the solar panel or AC adapter first. Damage may occur to the HOBO U30 Station if the battery is unplugged before disconnecting the solar panel or AC adapter.

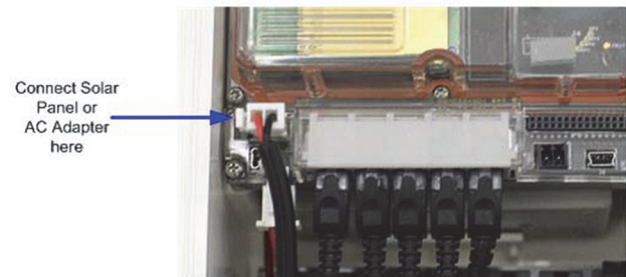

See *Configuring the Relay* if you are using a relay. See *Deploying and Mounting the Station* for installation steps and other deployment guidelines.

Reading Out the Station

To download data from the station:

1. Open the door on the station and connect it to the computer with a USB cable.
2. From the Device menu in HOBOWare Pro, select Readout. If the station is logging, select whether to stop or continue logging.
3. After the readout is complete, plot the data. Refer to the HOBOWare Help for details on working with the data.

Station Memory

The station contains 512 KB of non-volatile memory, which is retained even if the power runs out. If the station is set to stop logging when the memory is full, the amount of time it takes for the memory to fill depends on the number and type of sensors connected and the logging interval selected. The following figure shows the expected run time for several logging intervals based on the total number of bits in use by the logger, which is determined by adding the bits per sample for each sensor measurement used by the logger. For example, a station with a temperature sensor (12 bits), wind speed (16 bits), and two temperature/RH sensors (22 bits each) uses 72 total bits. Refer to the Specifications in each sensor manual for the bits per sample.

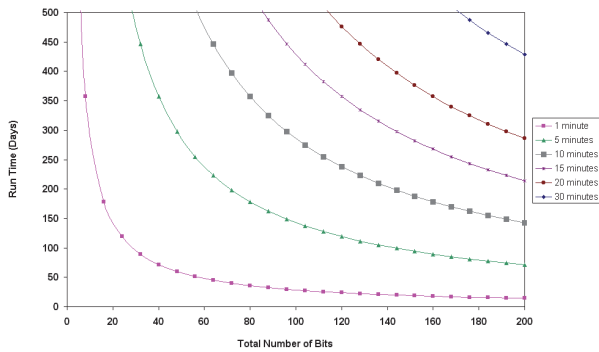

If the station is set to never stop logging (wrap when full), the oldest data will be overwritten with the newest data and logging will continue indefinitely.

Time Accuracy

The internal clock in the station is set by the time zone offset from UTC that you select when you configure the device. UTC, or Coordinated Universal Time, is similar to Greenwich Mean Time. The time zone offset makes it possible to determine objective, non-local time. This prevents conflicts and confusion before a Spring or Fall time change. Once the logger is logging, it will keep fairly accurate time. However, the following may cause errors with time reporting:

- Launch time loss. The HOBO U30 Station may lose up to two seconds when it is launched. This is unavoidable.
- Clock drift. The long-term time accuracy is related to ambient temperature. At 25°C (77°F), the worst-case error is ±8 parts per million (PPM), or about 5 seconds per week. The error increases as the temperature deviates from 25°C, as shown in the graph below. At a constant temperature of 20°C, the logger time error could be as much as 35 PPM (21 seconds per week).

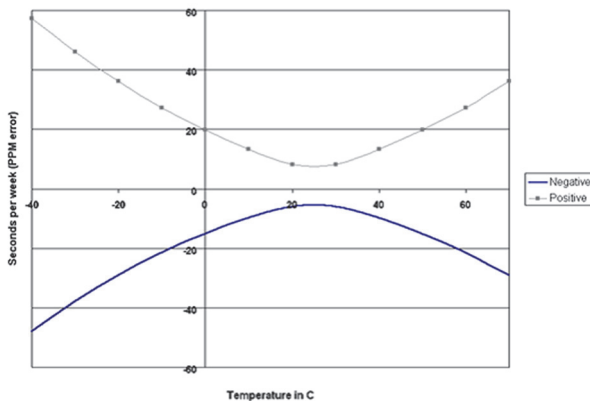

- Host Clock Error. The most likely source of error is an incorrect time or time zone setting on the computer that launched the logger. Make sure the clock on your computer is set to the correct date and time before launching the logger. One accurate resource is <http://www.nist.time.gov>.

Adding or Removing Sensors

Sensors can be added or removed while the station is stopped or while the station is waiting to start because it was configured to start logging on a specific date/time or with a push button start. To add or remove sensors from the logger:

1. Open the station door. Connect the station to the computer with a USB cable.
2. Read out and stop the logger with HOBOWare Pro.
3. Remove the rubber cable channel(s) and unplug any smart sensors or disconnect analog sensors you wish to remove.
4. For each sensor you are adding, lightly coat the smart sensor cable with a small amount of silicone grease (about the size of a pea).
5. Feed the sensor cables through the holes in the cable channel.
6. Plug in the smart sensors, connect the analog sensors, and reinstall the cable channel(s). Use rubber plugs to fill any empty holes. See *Setting up and Starting the Station* for more details on installing sensors. See *Deploying and Mounting the Station* for more details on the cable channels.
7. Configure the logger with HOBOWare Pro and start it again.

Notes:

- If you remove a sensor while the station is logging, the Logging LED will blink red at the next logging interval. The data for that sensor will then display as missing or erroneous in readouts.
- If you add a sensor while the station is logging, it will be ignored. Logging will continue normally for the other sensors.
- Smart sensors are listed in ascending order by serial number in HOBOWare Pro by default.
- The station can log up to 15 data channels (not including the internal battery channel). This includes two channels in the analog sensor port plus each of the smart sensor channels (note that some smart sensors may have more than one channel). If you have more than 15 channels connected, some of the sensors will be ignored. Disable the second channel in the analog sensor port if it is not needed.
- The station can work with a maximum of 100 meters (328 feet) of smart sensor network cable, which is the digital communications portion of the sensor cables. If you are using multiple smart sensors, check the length of each smart sensor network cable listed in the specifications in the sensor’s manual and make sure the combined length does not exceed 100 meters (328 feet).

Configuring the Relay

Upon an alarm condition, the relay contact on the station can be opened, closed, or pulsed to control the operation of an external device such as an irrigation system or fountain. The deactivated state (set in HOBOWare Pro) is the normal state of the relay when no alarm has been tripped to activate the relay.

If you want the relay to be open when there is no alarm, then set the deactivated state to open. If you want the relay to be closed when there is no alarm, set the deactivated state to close. You can also set a pulse relay alarm when the relay opens or closes.

Some common examples:

- An irrigation system on a cranberry bog or orchard turns on if the temperature drops below a certain temperature to avoid frost damage. In this case, the deactivated state of the relay is set to normally open and an alarm is set that changes the activated relay state to closed.

Equipment Normally Off

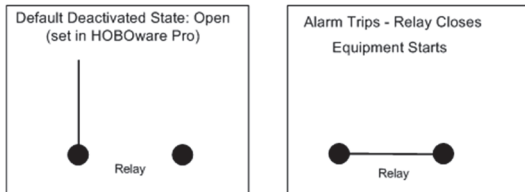

- A fountain that normally runs continuously turns off when the wind speed exceeds 20 mph. In this case, the deactivated state of the relay is set to normally closed and an alarm is set that changes the activated relay state to open.

Equipment Normally On

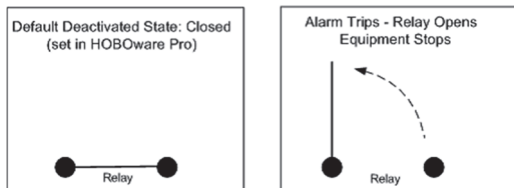

- You need to take a water sample when a water level reaches a certain amount. In this case, set the deactivated state of the relay to open and then set a pulse relay alarm. The relay will close briefly to activate a piece of external equipment and then open after a specified amount of time.

Pulse Relay

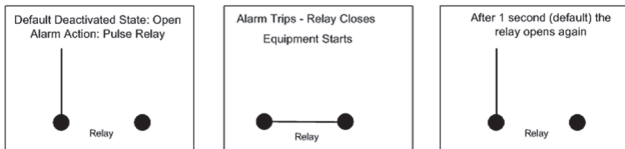

You can test a relay in HOBOWare by clicking the Close Relay/Open Relay button in the Sensor Alarm window described in the following steps. You should hear a click in the station when click the Close/Open Relay button. Click the button again to return to the default state. Use a digital multimeter to check for continuity to confirm the relay is opened and closed as expected.

To configure a relay:

1. From the Device menu in HOBOWare Pro, select Manage U30 and then Configure U30 Alarms.
2. Select a sensor and click Add.

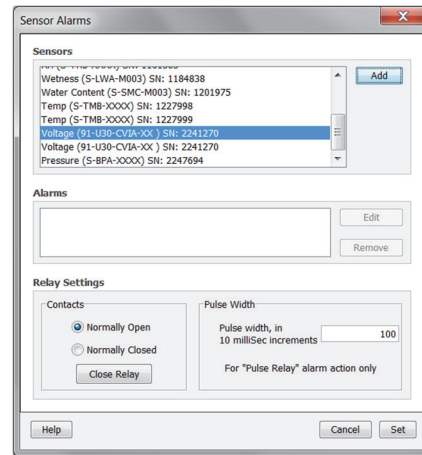

3. In the Alarm Configuration window, enable the High Alarm if you want an alarm to trip when the sensor reading rises above the high alarm value. Type a High Alarm value or drag the top slider to set a value.
 4. Enable the Low Alarm if you want an alarm to trip when the sensor reading falls below the high alarm value. Type a Low Alarm value or drag the bottom slider to set a value.
- Note:** The actual values for the high and low alarm limits are set to the closest value supported by the logger.
5. Set the number of samples that will be logged before the alarm trips. **Note:** To avoid unintended activation of the relay contact, set the number of samples to allow for anticipated breaches of the alarm threshold. If the measurement is still out of range when the number of samples is reached, the relay will be activated.

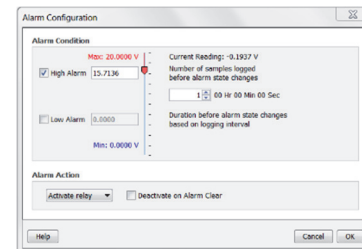

6. Select an action to occur when the alarm is triggered: Activate Relay, Deactivate Relay, or Pulse.
7. Select the Deactivate on Alarm Clear checkbox if you want the alarm action to stop automatically once the alarm condition clears.
8. Click OK. The alarm will now appear in the Sensor Alarms window.
9. Set the relay to Normally Open or Normally Closed.
10. If the alarm action was set to Pulse Relay in step 6, type the duration of the relay pulse.
11. Click Set to send the alarm configuration to the station.

Notes:

- If you do not want the relay to deactivate as soon as the alarm is cleared, you can set up another alarm to deactivate the alarm. For example, an alarm is set to trip when the temperature is 35°F, turning on the irrigation system. Instead of turning off the irrigation system when

the alarm clears (when the temperature rises above 35°F), you want to turn it off at 38°F. Make sure the Deactivate Alarm on Clear checkbox in the first 35°F alarm is unchecked. Then, create a second temperature sensor alarm with a high alarm above 38°F, an alarm action of Deactivate Relay and Activate Alarm on Clear unchecked.

- When multiple sensor alarms are configured, any one alarm can activate the relay when tripped.
- The relay on the U30 station is rated for a maximum of 30 V, 1 Amp. If you need to switch higher power devices use an appropriate external relay controlled by the station.

Deploying and Mounting the Station

Follow the guidelines and steps in this section for deploying and mounting the station.

Deployment Guidelines

When deploying the station:

- Make sure the station remains in a vertical position once it is placed in its deployment location to prevent pooling of water on the cable entries. If the station is mounting horizontally, the battery could be damaged over time as it is charged.
- If possible, avoid sites immediately adjacent to radio/television/microwave towers and equipment. In rare situations, strong electromagnetic interference may result in sensor network errors.
- Take note of the mounting considerations in the sensor manuals for additional guidelines for the sensors you are using.
- If you are using a wind speed/direction sensor or if the station will be installed on a roof or in a location with exposure to lightning, use a grounding wire. See *Installing the Grounding Wire*.
- Make sure all smart sensor cables are fastened securely and routed through the rubber cable channel. Any empty holes in the cable channels need to be filled with a rubber plug to ensure the station is weatherproof. See *Setting up and Starting the Station*.
- Do not store excess sensor cable wire coiled inside the station case or within one foot outside the case. The Leaf Wetness Smart Sensor (S-LWA) is especially sensitive and should be mounted at least two feet away from the case.
- Protect cables and wires with conduit. Exposed cables can be chewed by rodents.
- Make sure the total cable length for the digital sensor bus for all installed smart sensors does not exceed 100 m (328 ft). For cables with a smart sensor adapter, only the cable on the logger-side of the adapter count towards this 100 m (328 ft) limit.
- Consider using a padlock to restrict access to the station. With the door closed, hook a padlock through one of the latches on the right side of the door and lock it.

Installing the Grounding Wire

If you are using a grounding wire, insert the wire through the cable slot and plug it into the ground connector in the station. Make sure the thicker section of the grounding wire is placed in a sensor cable groove when installing the weatherproof cable channel (see next section).

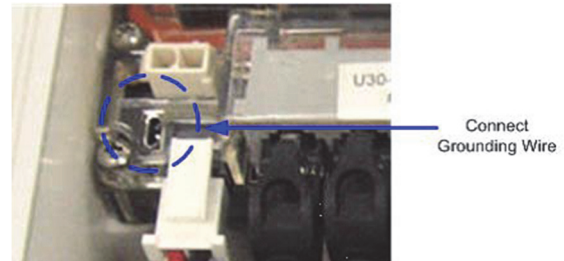

- If you are mounting the station on a tripod or mast, attach the grounding wire under one of the nuts on one end of the U-bolt.
- If you are mounting the station on a metal post, clamp the grounding wire to the metal post with a hose clamp or a 1-5/8 inch U-bolt.
- If you are mounting the station to a flat surface, attach the grounding wire to a proper ground.

Installing Weatherproof Cable Channels.

If the station will be deployed outdoors, follow these instructions to install the weatherproof cable channels in the primary and secondary cable openings.

1. Make sure all cables and wires are routed through the primary and secondary cable openings (cables from the smart sensor expander board should be routed through the secondary cable opening).
2. Apply a small amount of silicone grease (about the size of a pea) onto your fingertip and then work a light coating into the top, bottom, and two ends (the sides with no holes) of the smaller rubber cable channel. Also put a light coating on the inside of the two halves of the cable channel.

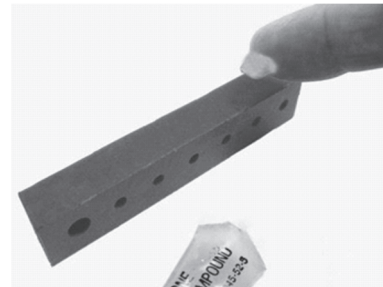

3. Hold the channel just below the station (with the channel's hinged side on the left and the taper facing in). Open the channel and lay the cables and wires into the grooves.
 - The solar panel or AC adapter cable must be in the leftmost (larger diameter) groove.
 - Use the small rubber plugs to fill any unused grooves. Center the thick part of the plugs in the groove. Plug 'tails' can face in or out. It may be easier to install these after the rubber cable channel has been pushed into the case. Insert the thin part of the plug

into the hole and pull to center the thick part of the plug in the channel.

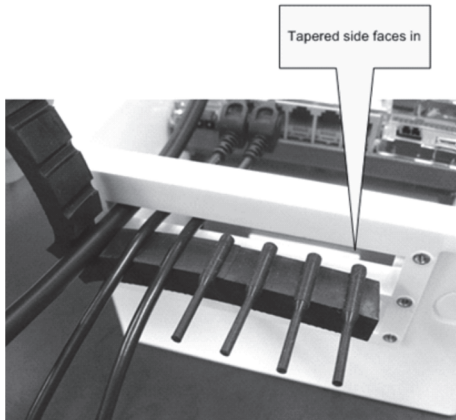

- Close the channel, making sure the cables, wires, and any plugs remain in their grooves. Press the channel into the opening. To reduce the amount of excess cable in the case (especially when several smart sensors are connected), gently pull the cables toward you as you press the channel into place. Press the channel in until it is flush with the outside of the case. When fully seated, the channel will project slightly into the inside of the case.

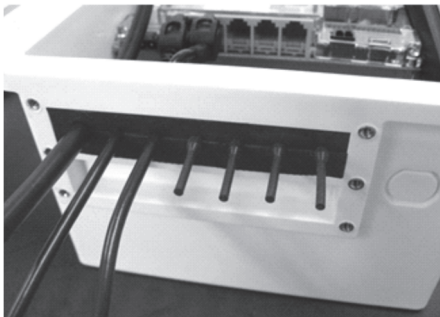

- If you are using the smart sensor expander board, repeat steps 2–4 with the second cable channel. Use the larger plug for the leftmost hole if necessary.
- Finger-tighten the retaining bars on to the case to secure the channel(s). Do not use a screwdriver to tighten the thumb screws. The bars should be flat against the case. **Note:** After time, you may need a screwdriver to loosen them in the field.

Tighten knobs clock-wise

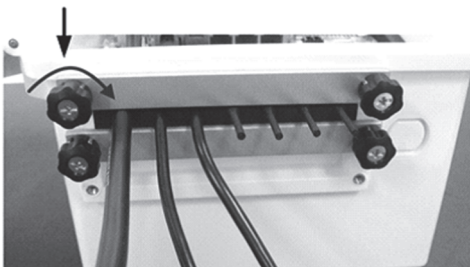

Mounting the Logger

There are three ways to mount the station:

- Mount the station vertically to a mast or pole using the U-bolts. Make sure the saddle clamps are mounted between

the pole and the mounting plates (installed in *Setting up and Testing the Station*), with the flat side of the clamps against the plates.

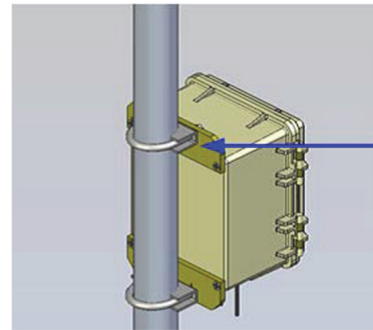

- Use the mounting plates to adhere the station vertically to a wall or board with screws.
- Use a tripod to mount the station. See the *Tripod Setup Guide* for details.

Care and Maintenance

The station is designed for outdoor use, but should be inspected periodically. When inspecting the station, do the following:

- Verify the station is free of visible damage or cracks.
- Make sure the station is clean. Wipe any dust or grime off with a damp cloth. Wipe any water off the station before opening it.
- Check that all cables are free of damage, such as cracks, cuts, and splits.
- Make sure cables are still fastened securely and any conduit is still intact.
- Grease the sides and bottom of the rubber cable channel and the portion of the cables in the cable channel with a small amount of silicone grease.
- Verify that all cables are free of corrosion. If moisture is visible inside the station or if there is any sign of corrosion on the connectors, spray WD-40® or an equivalent electronics-safe corrosion inhibitor on the connectors. This will displace moisture and prevent additional corrosion. Be sure to determine the source of the moisture and fix it. Check the cable channel and cover seal for any sign of moisture entry.

Troubleshooting

The following table lists common problems you may encounter with the station and possible resolutions.

Problem	Resolution
Individual sensors are not found or are missing in the Launch Logger window in HOBOWare Pro	<ul style="list-style-type: none"> If a sensor is removed and then immediately reinstalled, it may not be auto-detected. Click Refresh in the Launch Logger window. Check for a loose connection between the sensor and the logger. Make sure you haven't exceeded 100 meters (328 ft) of network cable. If you are using the smart sensor expander board, make sure it is connected to the station with the expander cable.

Problem	Resolution
	<ul style="list-style-type: none"> Make sure you have not exceeded 15 data channels. Use HOBOWare Pro to see a list of all sensors in the Launch Logger window. Smart sensors are listed in ascending order by serial number. If more than 15 data channels are connected, the sensors with the higher serial numbers will be ignored and their data will not be recorded.
All sensors are missing in the Launch Logger window in HOBOWare Pro	Remove all but one sensor, then check if the sensor appears in the Launch Logger window (you may need to click the Refresh button). Continue to plug and unplug each sensor one at a time until you find the bad sensor. If you find a bad sensor or if none of the sensors communicate, contact Onset Technical Support.
Logger is not found in HOBOWare Pro	<ul style="list-style-type: none"> Make sure the USB cable is fully inserted in the USB port. Check the computer's COM port/USB settings in the HOBOWare Pro preferences. Make sure the battery is charged.
The Logging LED is blinking red or orange	<ul style="list-style-type: none"> Look for loose sensor connections. If any are found, remove the offending sensor and check its wires and connector for damage and/or signs of moisture. Check the sensors one at a time to make sure they are all communicating as described in the previous problem. If you find a bad sensor or if none of the sensors communicate, contact Technical Support. In general, it is recommended that you read out data when this light is blinking red or orange, investigate the problem, and restart the logger.
No status LEDs are blinking	<ul style="list-style-type: none"> The LEDs are very faint under direct sunlight. Shield the station from light and check the LEDs again. Make sure the battery power is not too low. There needs to be at least 3.6 volts for logging to continue. The memory is full. Read out the logger and launch it again. The launch configuration settings may not have been loaded to the station. Check the status with HOBOWare Pro.
The Logging LED is not blinking	<ul style="list-style-type: none"> The logger may have been configured to start at a specific date/time, on an interval, or with a button start. The launch configuration settings may not have been loaded to the logger. Check the status with HOBOWare Pro.
The battery quickly runs out of power	Make sure the solar panel is installed properly and functioning. The solar panel should provide enough power to recharge the battery during the day. Or, use the AC adapter to recharge the battery.
The battery power has run out	<p>Recharge the battery for 12 hours with the AC adapter. If it cannot be recharged, you will need to replace the battery. Contact your Onset Authorized Dealer or Onset Technical Support. Note: The station uses durable, high-capacity Flash memory so that data is retained even when the battery runs out of charge.</p> <p>Do not relaunch the station until the data has been recovered. If the battery cannot be recharged and you are still unable to read out the station, contact</p>

Problem	Resolution
	Onset Technical Support. It may be possible to retrieve the logged data.
Data file can't be opened	The data file may be corrupted. Read out the station again and try opening the file. If that does not work, contact Onset Technical Support.
Data file contains errors	If data is missing for a particular sensor, check that the sensor was installed correctly. Unplug the sensor and then plug it back in. Make sure the sensor appears in the Launch Logger window in HOBOWare Pro (you may need to click the Refresh button). If it does not, contact Onset Technical Support.

Battery Information

The station uses one rechargeable 4 volt, 10Ah, sealed lead-acid battery. Use the AC adapter (AC-U30 or AC-U30-EU) or solar panel (SOLAR-xW) to keep the battery charged. If using a solar panel, the quality and quantity of solar light can affect whether the battery is sufficiently charged to last through the night and cloudy periods. The 5 Watt, 6 Volt solar panel (SOLAR-5W) is recommended for most applications. The 15 Watt, 6 Volt solar panel (SOLAR-15W) is recommended for very cloudy locations or higher latitudes.

Without a charging device connected, expected battery life varies based on the ambient temperature where the station is deployed, the logging or sampling interval, the number of channels that are active, excitation in analog modules, the number of tripped alarms, and other factors. Deployments in extremely cold or hot temperatures, a logging interval faster than 1 minute, or a sampling interval faster than 15 seconds can impact battery life. Estimates are not guaranteed due to uncertainties in initial battery conditions and operating environment.

Use the following table as a guideline for estimating how long the station will run using a fully charged battery and no source of external power. For these examples, the station has up to 10 smart sensors installed and no excitation enabled for the analog sensor module.

Logging Interval	Typical Run Time
1 second	2 to 3 months
1 minute	6 months
5 minutes	6+ months

Note: It is not recommended that the U30 be deployed for longer than 6 months without any charging as the battery may be damaged from sulfation due to the long-term low-voltage state.

To maximize battery life:

- If using excitation voltage, select the shortest warm-up time needed for the sensor.
- Ensure that the solar panel gets full sunlight. Solar panels are extremely sensitive to partial shading. Obstructing even a single cell of the panel will result in significant loss of charging power.
- Use the sampling interval only if you have sensors that support measurement averaging.

- Stay within the normal operating temperature range. While the logger can operate at temperatures of -40 to 60°C (-40 to 140°F), the battery has much better short and long term performance when maintained between -20 and 40°C (-4 and 104°F). The Sealed Lead Acid will self-discharge. The hotter the battery gets, the faster it will self-discharge.
- At 20°C, the battery loses about 20% of its capacity in 6 months, but at 50°C it loses more than 50%. To maximize battery life (no charging) try to locate the logger where the temperatures will not be above 40°C (104°F). Very cold temperatures will reduce the self-discharge rate to almost zero, but the effective capacity of the battery will be reduced. Temperatures below -20°C (-4°F) will reduce the effective battery capacity by more than 25%.

The station will stop logging if the battery voltage drops below 3.6 V. If the station has stopped logging due to low battery voltage, plug in an AC adapter or solar panel. It may take several minutes for the station to power back up; the lower the remaining voltage, the longer it will take for power to return. Also note that it will take longer for power to return with a solar panel than with an AC adapter. If the charging device is not recharging a dead battery, contact Onset Technical Support.

Important: Due to the self-discharge characteristics of this type of battery, it is imperative that you charge the battery for at least 12 hours every six months at minimum, even if you are not actively using the station. Otherwise, permanent loss of battery capacity may occur.

If the battery is completely dead and recharging is not an option, follow these steps to replace the battery:

1. Disconnect the AC adapter or solar panel.
2. Disconnect the battery.
3. Unplug all sensors, the USB cable, relay, and grounding wire.
4. Use a Phillips-head screwdriver to remove the four screws at the corners of the clear, inner case.
5. Remove the clear, inner case.
6. Use a Phillips-head screwdriver to remove the two screws that secure the battery.
7. Note the orientation of the battery and then remove it.
8. Install the new battery with the same orientation and reverse the steps to reassemble.
9. Dispose of the old battery per local regulations.

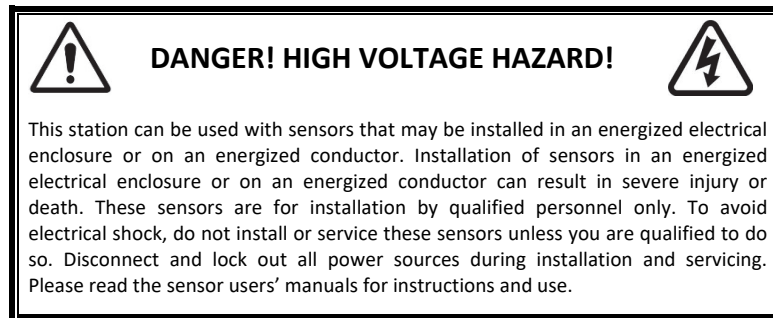

FCC Part 15 Compliance

Disclaimer and Revisions

This equipment has been tested and found to comply with the limits for a Class B digital device, pursuant to Part 15 of the FCC Rules. These limits are designed to provide reasonable protection against harmful interference in a residential installation. This equipment generates, uses and can radiate radio frequency energy and, if not installed and used in accordance with the instructions, may cause harmful interference to radio communications. However, there is no guarantee that interference will not occur in a particular installation.

If this equipment does cause harmful interference to radio or television reception, which can be determined by turning the equipment off and on, the user is encouraged to try to correct the interference by one of the following measures:

- Reorient or relocate the receiving antenna.
- Increase the separation between the equipment and receiver.
- Connect the equipment into an outlet on a circuit different from that to which the receiver is connected.
- Consult the dealer or an experienced radio/TV technician for help.

This device complies with Part 15 of the FCC Rules. Operation is subject to the following two conditions: (1) This device may not cause harmful interference, and (2) this device must accept any interference received, including interference that may cause undesired operation.